

SNAKESKIN

Cobra Car Club of WA Newsletter

2005 July Edition.

Volume 12

DO YOU WANT TO BE EDITOR ? Page 10

Belmont 'Grand Prix' go karts Page 3



The ... **"FANTASTIC 4"** ... page 7

EBAY Bargain 2005

ORIGINAL FACTORY 1963-65 SHELBY AC 289 COBRA - AM RADIO

ULTRA RARE FACTORY OPTION FOR COBRAS

Item number: 4553470806

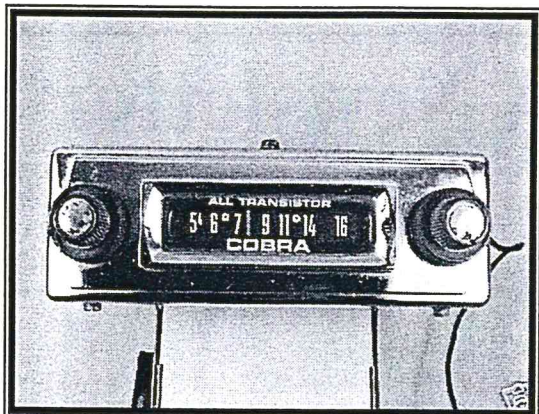

Starting bid: **US \$3,000** (Reserve not met)

~~Buy It Now~~ price: **US \$5,000.00**

Time left: **4 days 13 hours**
5-day listing, Ends Jun-04-05 20:07:43 PDT

Start time: May-30-05 20:07:43 PDT

History: 0 bids

Item location: eBay
United States

Ships to: United States

Shipping costs: Check item description and payment instructions or contact seller for details



[Shipping and payment details](#)

ULTRA RARE FACTORY OPTION. The **COBRA RADIO** was an extra cost option for 289/427 Cobras from **SHELBY AMERICAN** in the 60's but few were installed and even fewer have survived. Today they are nearly impossible to find for sale. This original radio is in excellent condition. I've never tested it but nothing about it looks abused and it's appears to have had little use. Excellent chrome. Original knobs. Excellent clear plastic dial face with no cracks or fading. The speaker is built into the top of the radio case.



Editors Note

A neat little item from Ebay recently— just the thing to sing along with on those early morning runs. Unfortunately it doesn't pick up 96FM. Or maybe the club member with the dented aluminium Cobra can put it in his car to make it look even more genuine, after all it's only

... \$6,586.75 AUD

The annual 'Belmont Go Kart' night has just been run and won. Rob Payne had organised the whole thing and is to be congratulated on such a magnificent turn out. We had 36 racers and a large number of spectators for the function.

It was one of those cold wet July nights we experience in the middle of a Perth winter; but it didn't stop the members and friends and kids (I mean sons and daughters of members and friends!!)

There were six races with six drivers in each race and we all got three races each to be able to clock the fastest lap times. The drivers of the six fastest lap times of the night qualified to be in the last race using the super karts.

This race night was a little different to all our other race nights because we had six or seven young ladies racing with us. They were selected with one lady in each team of six. As usual with these events—if you lose—blame the kart, if you win its because of your skill behind the wheel and there were a lot of excuses from the losers. As for me it was my skill behind the wheel and the excellent kart I had and the good tyres on the kart and my bravery to fight off attackers trying to go faster than me. I had good karts all night and had a great

time, there was plenty of pushing and shoving as we jockeyed for positions to be able to clock the fastest lap times to have the chance at the super karts.



Throughout the night the lap times were printed out for display and I kept a close eye on how I was going but noticed the quickest times seemed to be coming from the teenagers! Bingles and crashes were plentiful—not that I had one, but I know I caused a couple when shunting a driver that wasn't willing to pull over and politely let me pass! In the last race I was slammed in the back so hard—my eyes momentarily saw the inside of my skull—and we were on the stopping lap under the flashing orange lights, it was that new Cobra owner Dave Manson, I think, he may need glasses or it may have been a revenge shunt from an earlier incident where I may have just tapped him lightly when passing in an earlier race.

BELMONT GO-KARTS.....cont- from page 3

The final race of the Super Karts came and the names of the drivers were called out, most the names were familiar but different—they were Matthew Manson, Kim McClymans, Cameron Plank and three other young people, there were no oldies in the six. At this point some old fossil with a camera hanging around his neck came out of the crowd and started going off about— “It is always members kids who win these events —AND WE SHOULD STOP BRINGING THEM”.



I stood on the side line with my camera around my neck watching all these kids having so much fun, it just wasn't fair, but I consoled myself by thinking that I may have been number seven on the list and just missed out, (yeah, in my dreams).

Well they had a ball and so did I, **THE WINNER** was 'MATTHEW MANSON', second was Vicki and third was Cameron Plank, well done to them all. The rest of us will just have to try harder next time.

Editor... Harrymac.



*Above:
The drivers briefing
before the fun began.*

*Left:
This was as close as
Ron McNally got to
the first place podium*

The chance of a lifetime. CARROLL SHELBY HAS OFFERED A COBRA ...CSX 1000 TO BE RAFFLED FOR THE "CHILDRENS FOUNDATION"

WIN CARROLL SHELBY'S COBRA



All Proceeds Benefit
**CARROLL SHELBY
CHILDREN'S
FOUNDATION**
www.shelbychildrensfoundation.org
310.327.1072



The original is back and it could be yours! This is your chance to enter the Win-A-Shelby Raffle. You could be the owner of this exclusive Shelby/AC Cobra CSX1000.

Aluminum Body • 427FE Shelby Engine • Billed to Carroll Shelby

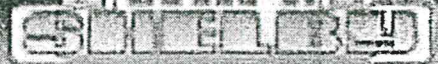

\$25 Donation = 1 Ticket \$100 Donation = 5 Tickets

Drawing to be held January 25, 2006. Winner must be 18 or younger at the time.

Tickets are for personal use only. All proceeds from the raffle will be donated to the Carroll Shelby Children's Foundation. For more information, visit our website at www.winashelby.org. Tickets are available at the Carroll Shelby Children's Foundation, 19021 South Figueroa Street, Gardena, CA 90248. Tickets are available until the drawing on January 25, 2006. All proceeds from the raffle will be donated to the Carroll Shelby Children's Foundation. For more information, visit our website at www.winashelby.org.

SPONSORED BY:

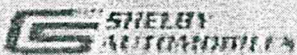

WWW.WINASHELBY.ORG

Name _____

Address _____

City _____ State _____ Zip _____

Phone _____ Cell _____

Number of Tickets _____ @ \$25 or \$100 = TOTAL \$ _____

Payment Method: Check enclosed (make payable to Carroll Shelby Children's Foundation)
 Credit Card Visa MC AMEX DISCOVER

Contributor _____ Exp. Date _____

NOTE: Credit Card must be issued in the name of the donor as stated above.
Mail to: Carroll Shelby Children's Foundation, 19021 South Figueroa Street, Gardena, CA 90248.

New words for 2005 Workplace vocabulary

TESTICULATING Waving your arms around and talking Boll*ocks.

BLAME STORMING. Sitting around in a group, discussing why a deadline was missed or a project failed, and who was responsible.

SEAGULL MANAGER. A manager who flies in makes a lot of noise, craps on everything, and then leaves.

ASSMOSIS. The process by which people seem to absorb success and advancement by sucking up to the boss rather than working hard.

SALMON DAY. The experience of spending an entire day swimming upstream only to get screwed and die.

CUBE FARM. An office filled with cubicles.

PRAIRIE DOGGING. When someone yells or drops something loudly in a cube farm, and people's heads pop up over the walls to see what's going on. (This also applies to applause from a promotion because there may be cake.)

MOUSE POTATO. The on-line, wired generation's answer to the couch potato

SITCOMs. Single Income, Two Children, Oppressive Mortgage. What yuppies turn into when they have children and one of them stops working to stay home with the kids or start a "home business".

STRESS PUPPY. A person who seems to thrive on being stressed out and whiny.

PERCUSSIVE MAINTENANCE. The fine art of whacking the crap out of an electronic device to get it to work again.

ADMINISPHERE. The rarefied organisational layers beginning just above the rank and file Decisions that fall from the "adminisphere" are often profoundly inappropriate or irrelevant to the problems they were designed to solve. This is often affiliated with the dreaded "administrivia" - needless paperwork and processes.

404. Someone who's clueless. >From the World Wide Web error message "404 Not Found," meaning that the requested document could not be located.

OHNOSECOND That minuscule fraction of time in which you realise that you've just made a BIG mistake (e.g. you've hit 'reply all') - New Oxford Dictionary Definitions:

GOING FOR A McSH*IT Entering a fast food restaurant with no intention of buying food, you're just going to the bog. If challenged by a pimply staff member, your declaration to them that you'll buy their food afterwards is known as a McShi*t with Lies.

AUSSIE KISS Similar to a French Kiss, but given down under.

BEER COAT The invisible but warm coat worn when walking home after a booze cruise at 3am in the morning.

BEER COMPASS The invisible device that ensures your safe arrival home after booze cruise, even though you're too drunk to remember where you live, how you got here, and where you've come from.

BOBFOC Body Off Baywatch, Face Off Crimewatch.

BREAKING THE SEAL Your first pee in the pub, usually after 2 hours of drinking. After breaking the seal of your bladder, repeat visits to the toilet will be required every 10 or 15 minutes for the rest of the night.

GREYHOUND A very short skirt, only an inch from the hare.

JOHNNY-NO-STARS A young man of substandard intelligence, the typical adolescent who works in a burger restaurant. The 'no-stars' Comes from the badges displaying stars that staff at fast-food restaurants often wear to show their level of training

Many people have lots of friends, some have a select few hand picked friends and others have no friends. As a young man I had many friends, everyone I met became my friend, as I grew older my friends seemed to become a select few, picked from whatever interest I was involved in.

The Cobra Club is one of those interests at the moment and I have many friends and within that selection there are many whom I admire and respect and would call good friends.

On Sunday 17th July some of those good friends came to my house with a plan to turn my chassis into a rolling chassis ‘Stage 1’ - this challenge was instigated by Ron McNally when we were at Wandering for the weekend enjoying too much wine (bloody McNally!!!). Ron being the ever so sharp financial planner, set about planning the building of my Cobra in stages for a licensing target of February 2006. Me—being the ever so sharp butter knife under the influence of many fine wines accepted the challenge. It wasn’t till I got home the following day when I realised what I had just stepped in, of course, Ron rang to confirm the deal a couple of days later so I knew he was serious—Oh Boy!! I had bitten off a lot more than I could chew, so now I am chewing like mad—but I have found a few good friends who are taking delight and helping me chew.

A date was set for ‘Stage 1’ and the plan started. First I took the Series 2 Jaguar LSD rear end to Roadbend and asked them to fully recondition it—brakes and all. I then started to clean up all the front end bits and pieces—sanding and grinding most of the casting marks out of them and sent them off for plating—I also sourced out new front discs, exchange 4 pot calipers, front bearing kits, upper and lower ball joints, a heap of new Nylok nuts, plated bolts, washers, brake lines, etc, etc, etc. Brian Plank gave me a VK Commodore power steering rack and that got sent off to be fully reconditioned.

Before the required date I had to weld a floor into the chassis and paint it. The 17th July arrived and all was ready to go, the chassis was painted, one coat only ‘Killrust’ Aluminium Silver (looks good!) all the bits and pieces were lined up on the bench and sorted into their various lots. The Cobra was outside on the back verandah, the garage was clean again and the chassis was on stands in the middle of the floor waiting for the “Fantastic 4” to do their stuff.

Sunday 9.15am was a bitterly cold morning when the Mandurah mob arrived—Dick Hogen Esch and Ron McNally were in Dick’s Cobra and Dave Bennie in his, shortly followed by Brian Plank in his you-beaut Ute and new Canadian Club Hat to keep himself warm for the trip from Kingsley to Craigie.

We started with teas and coffees to warm the bodies a bit before charging into the work. There were lots of silly comments about the clean garage, (I think I should go around and see some other members garages and sheds to get an idea as to how a garage is supposed to look) because I always get ribbed about having a clean garage—but they didn’t see it the week before!!

One thing I was looking forward to was learning from the collective 4 about assembling and fitting Jaguar front and rear ends, I thought their combined knowledge and experience in such matters about Cobras would make me as clever as them. **That plan failed;** they all started assembling things and other things and things that bolted to more other things and all they did was just keep me fetching more things for them to bolt together. So! I still don’t know anything about Jaguars, just that it all goes together very easy and quickly in the right hands. After a while when they settled in with the assembly, I kept getting chances to start putting a few things together myself but every time I started, I was called to get a tool or something that was missing to keep the flow of work running smoothly—before you knew it—it was lunch time.

I fired up the BBQ, got the sausages, onions and buns already to go—then got another call for something else that was needed NOW!!. By the time I got back to the BBQ Plankie had it all under control, so I left him to it and went back to fetching for the others. We all had plenty to eat and drink, then they were straight back into it.

Dick armed himself with the torque wrench and started torqueing— while Dave Bennie didn’t stop talking all day long. The whole day went very well, with many laughs and jokes along the way, the Cobra chassis also went well, just a few minor things missing (didn’t come back from the platers), so by the time the Mandurah Boys left around 3.30pm (I think), the chassis was almost ready for the wheels and types. 3.30pm Brian and I sat down for a cup of tea and a chat, I surprisingly realised I was still wearing my slippers – being flat out the whole time, I just forgot to take them off— I was exhausted, but very happy with the result.

Before Ron, Dick and Dave left, they gave me a list of things I had to do before I can bolt the wheels on, just simple little things I can handle. They also gave me the plan for ‘Stage 2’—engine, gearbox, pedal assembly, brake system, brake and fuel lines etc., etc., etc., all for the last Sunday in August. So, I am still chewing like mad, but with friends like Ron, Dick, Dave and Brian all chewing with me, I am very confident ‘Stage 2’ will also be achieved on time.

To them all—thanks for the help, the motivation and the laughs. To Ron a big thanks for taking the time and care to push me and setting up a plan. Final note“IT LOOKS FANTASTIC”

Harry Mac

The 'FANTASTIC 4' at work - July 17 on Harrymac's - COBRA -

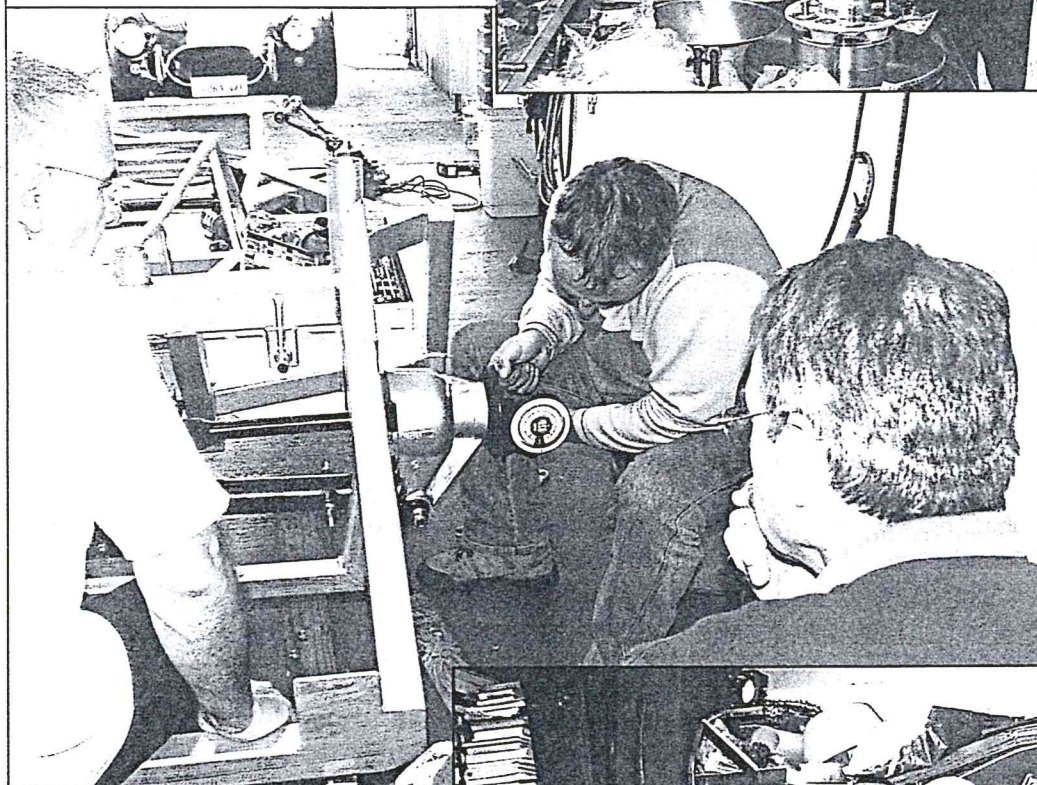
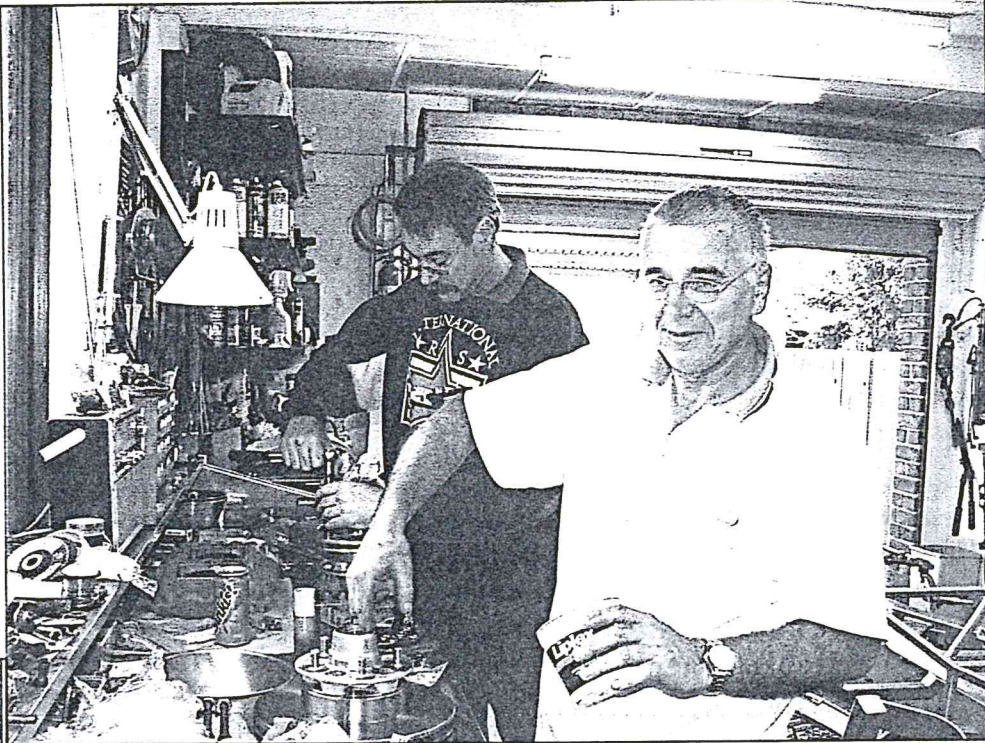

above:
Dick Hogen Esch bolting the new disc's to the hubs while Ron McNally greases the hubs — from the look on Ron's face he must have been remembering a prostate exam.

above:
Dave Bennie consulting with Ron and Dick about the number of shims needed on the Jag rear end to make the wheels plumb. (note: it was about 4mm's of shims each side)

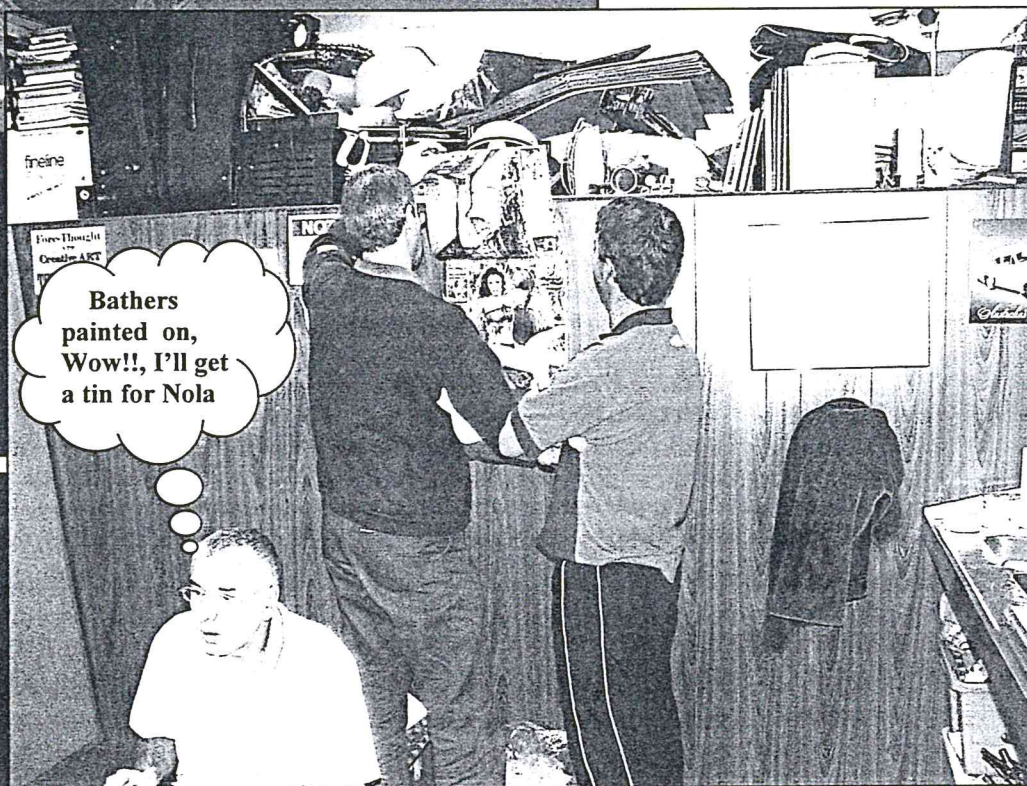

right:
Dick and Brian took almost two hours before they noticed the 'PLAYBOY' calendar on the back wall of the garage, they were very excited to find out that the bathers were painted on the models. Mmm!

What they started with:-

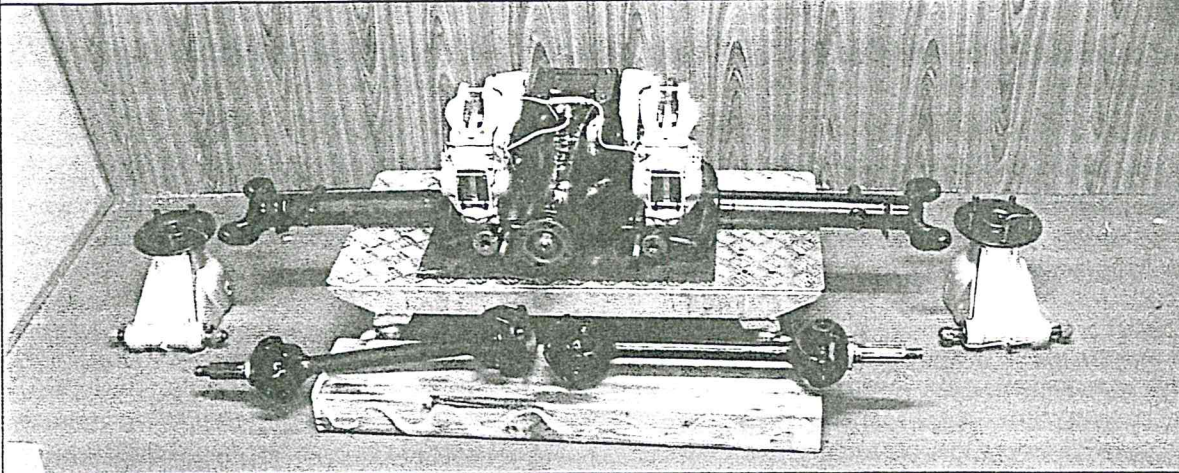

1.

Reconditioned Jaguar LSD diff and rear end ready for assembly .

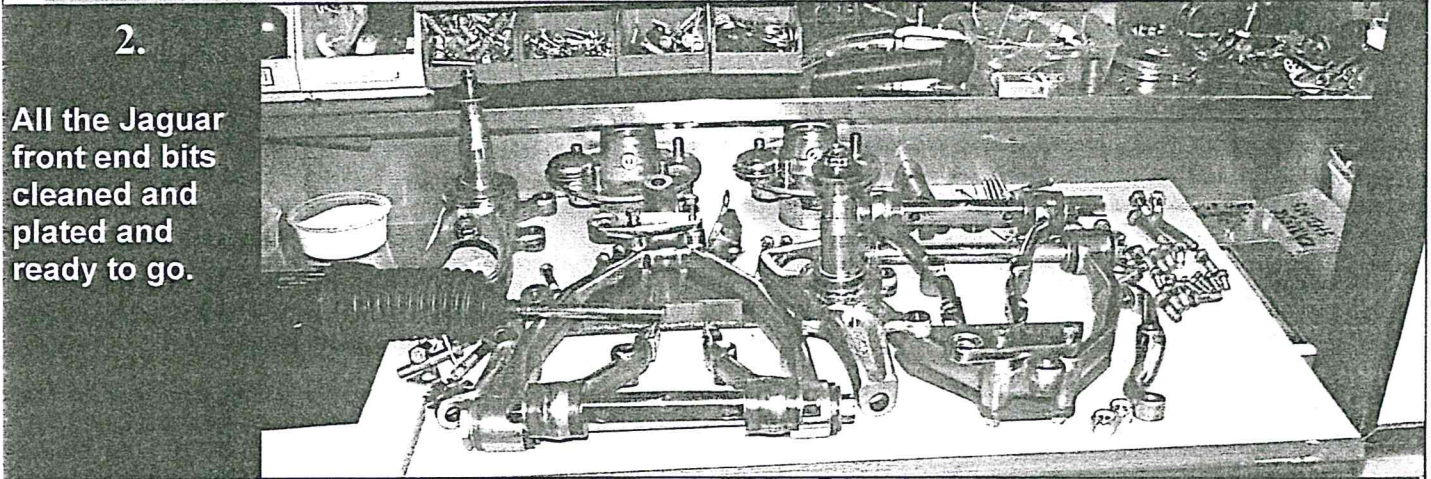

2.

All the Jaguar front end bits cleaned and plated and ready to go.

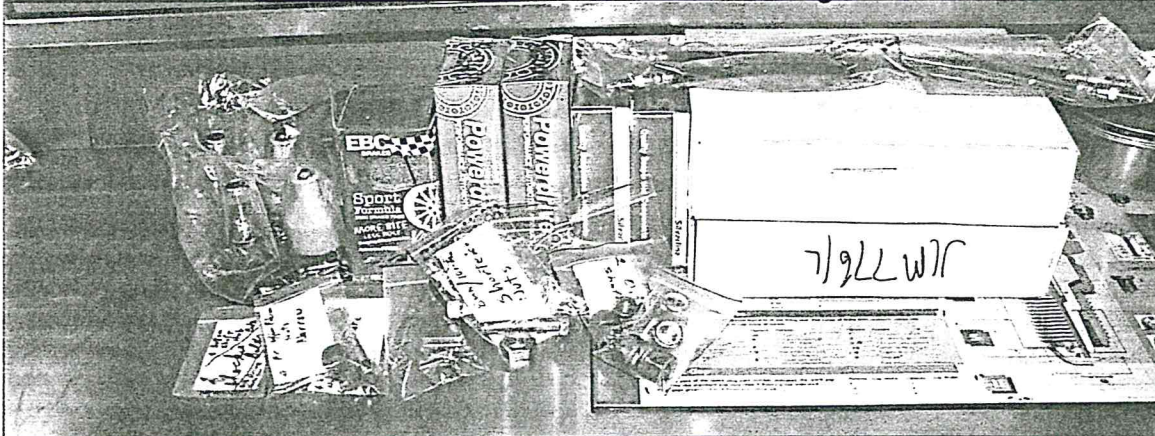

3.

The Jaguar other bits and pieces—discs, bearings, ball joints, brake pads, all kinds of stuff.

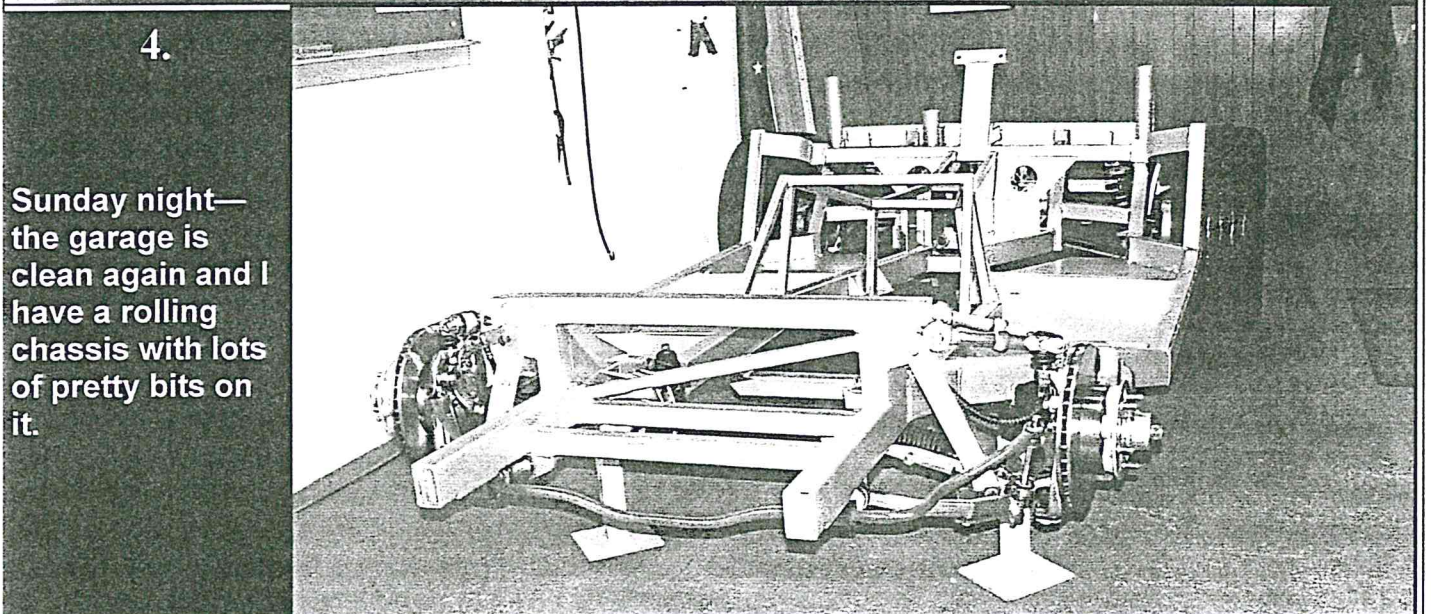

4.

Sunday night—the garage is clean again and I have a rolling chassis with lots of pretty bits on it.

“ HOW TO BE AN EDITOR ”

By the time you are reading this, the Club will have a new editor for the Snakeskin, duly elected at the AGM in July.

I won't say—being the club editor—is an easy task because it isn't but I have found it to be enjoyable over the many times I have held the position. It is a very time consuming job of first finding something to write about, you may think there is lots to write about, but when it comes to sitting down with you pen and paper—you go blank.

Going on runs and weekends away helps because you just write about the trip and the antics the members get up to while away. Every trip or run I have been on has been a very funny experience, I found amongst the members and friends—there are no bosses or bullies—everyone just gets on well together. There are also a couple of events to write about, such as the Show & Shine and the Whiteman's Classic Car Show along with Go Kart racing and the odd trip to somewhere unusual.

I always enjoyed relating an experience from my past, mainly the funny bits—not the bits that would make you go—“Oh dear, who would of thought he did something like that!!” One regret I have of my time as editor was I didn't have a section for builders, where there would be handy hints and tips to make building your Cobra easier. I tried to get a regular feature going of a builders story, along with photos, but it seems most people don't want to or just didn't have time so the idea was dropped.

On occasion you could get a member (or a member's wife) to write an article about one of the runs away or a holiday they went on and what they did while they were there. Many members have contributed stories to the Snakeskin over my time as editor and I would like to thank them all, another thank you is to the members who have written to me with words of praise and thanks, these letters are very dear to me and I will keep them for some time. Every time I have received one of these letters, I felt quite humbled, as I have never considered my writings being of any great literary acclaim, but to know someone has enjoyed a story or an article so much they have put pen to paper to let me know how much pleasure they had reading it—so thank you guys—you know who you are.

What do you need to be the editor of a club magazine?

1. You will need a decent computer because this is where it all starts to come together with writing and storing stories and articles for your publication.
2. It is a good idea to have the internet, preferably broadband to make it easier and quicker. There is such a wealth of information at your fingertips when you are searching for something—it sure beats the hell out of driving to several libraries to search for information only to find—they don't have it, or never heard of it, or try another library. The internet has it all—and its free!
3. A good photocopier is an advantage and saves the club money and yourself a lot of time, it also helps you see what it looks like right away instead of waiting to go somewhere and get it photocopied.
4. The digital camera is a must and it must be a good one—not one of the July specials at “Red Dot” or WA Salvage—because with a poor quality camera you can't help but produce a poor quality photo. With the digital camera you can just download straight onto the computer and edit the photo to suit your needs.
5. You will need an active imagination to add a bit of colour to a story—this could be your interpretation of an event the way you saw it—and if someone sees it differently to you—then you suggest they write it how they saw it and you then have another story for the Snakeskin. (don't let the truth get in the way of a good story!)
6. If you have a whinge or a complaint about a member's behaviour or the Club's handling of something, keep it short, to the point and separate from stories and articles, no one wants to read a two page lecture about how a member drove too fast in the tunnel and made a —————>

deafening noise in such a confined space or how the members at the front of the con-
voy took off into the distance leaving the rest of the drivers wondering where they had gone.
You are not their mother, they are grown men and they know the consequences.

7. Sense of Humour—if you haven’t got one—forget it—your publications will be dull and
boring, if members want to read the news of the world— they will buy a newspaper. When a
member gets his or her Snakeskin they want light reading and hopefully a few laughs and
catch up on what we are all doing in the Club and on the runs, because a lot of members can’t
make the meeting or the outings and runs.

So there you have it— now anyone can do it. Rumour has it, that we may have a “Lady Edi-
tor”.... for the future “Oh No!” you say and you can see the Snakeskin stories—about Tom
Cruise and his latest love and what Paris Hilton has just done and will Prince Charles and
Camilla have any children or the best ways to trim you thighs—”Forget It!” it will never happen.

The Lady in question has been a member for a long time, has been at almost every meeting and
run and weekend away, she can also drive a Cobra by not looking at the road but enjoying an
in-depth conversation with her lady friend passenger. She can tell you more about the speed-
way and rally driving than you can probably get from books or magazines and, never the less,
she remains a Lady—and I wish her well if she takes on the new role of “Snakeskin Editor”.

Editor Harry Mac.

WANTED

New Editor



Now you can service your own Cobra, with the Shell service card from England circa: 1963.
I have recently purchased the guide from EBAY.



SERVICE GUIDE

PASSENGER CAR

No. 67 PC

1st REVISION

ITEM	APPLICATION	SHELL GRADE	MILEAGE	REMARKS
<i>All capacities are refill quantities</i>				
1	Engine (6½ pints)	SUPER 100	Daily 2,000*	Top up if necessary Drain, flush (when oil filter service required), refill
2	Gearbox (2½ pints)	SPIRAX 90 EP	3,000 4,000*	Top up if necessary Drain, flush and refill
3	Rear axle (2½ pints)	SPIRAX 90 EP	3,000 4,000*	Top up if necessary Drain, flush and refill
4	Spring ends—front and rear	RETINAX A	500	Gun—4 nipples
5	Steering swivel pins	RETINAX A	1,000	Gun—2 nipples
6	Handbrake cables	RETINAX A	5,000	Gun—2 nipples
7	Propeller shaft universal joints	RETINAX A	2,000	Gun—2 nipples
8	Drive shafts—splines —universal joints	RETINAX A RETINAX A	2,000 2,000	Gun—2 nipples Gun—4 nipples
9	Wheel bearings	RETINAX A	10,000	Gun—4 nipples— lubricate sparingly
10	Oil filter	—	5,000	Renew element
11	Air cleaner—dry type	—	5,000 36,000	Remove, clean, replace Renew element
12	Oil filler cap	SUPER 100	5,000	Remove, wash in petrol, dry, dip in oil, drain, replace
13	P.C.V. system	—	10,000	Replace valve, clean all parts
14	Dynamo	SUPER 100	10,000	Oil can—1 oil cup lubricate sparingly
15	Distributor	SUPER 100	3,000	Oil can—oil hole— 1 or 2 drops
16	Accelerator linkage	SUPER 100	3,000	Oil can—few drops
17	Steering gearbox—pinion	RETINAX A	4,000	Gun—1 nipple— lubricate sparingly
18	—rack	SPIRAX 140 EP	10,000	Remove clip on rubber gaiter, inject, replace clip
19	Brake and Clutch fluid supply tanks	—	1,000	Top up if necessary with recommended brake/clutch fluid

*Initially after 1,000 miles.

SERVICE PERIOD SUMMARY

FREQUENCY	ITEMS REQUIRING ATTENTION
Daily	1
500 miles	4
1,000 miles	5-19
2,000 miles	1-7-8
3,000 miles	2-3-15-16
4,000 miles	2-3-17
5,000 miles	6-10-11-12
10,000 miles	13-14-18
36,000 miles	11

For information on regular maintenance jobs other than lubrication, reference should be made to the manufacturer's instruction book.

(continued overleaf)

TYRES
SIZES
6.40-15

PRESSURES
(lb. sq. in.)
Front Rear
28 33
to 30 to 35

ENGINE ADJUSTMENTS

Valve clearances—hydraulic non-adjustable
Contact breaker points gap018" to .021"
Spark plug gap035"

APPROXIMATE CAPACITIES
(Litres/Imperial measures)

Cooling system13.7 litres/24 pints
Fuel tank69.0 litres/15 gallons

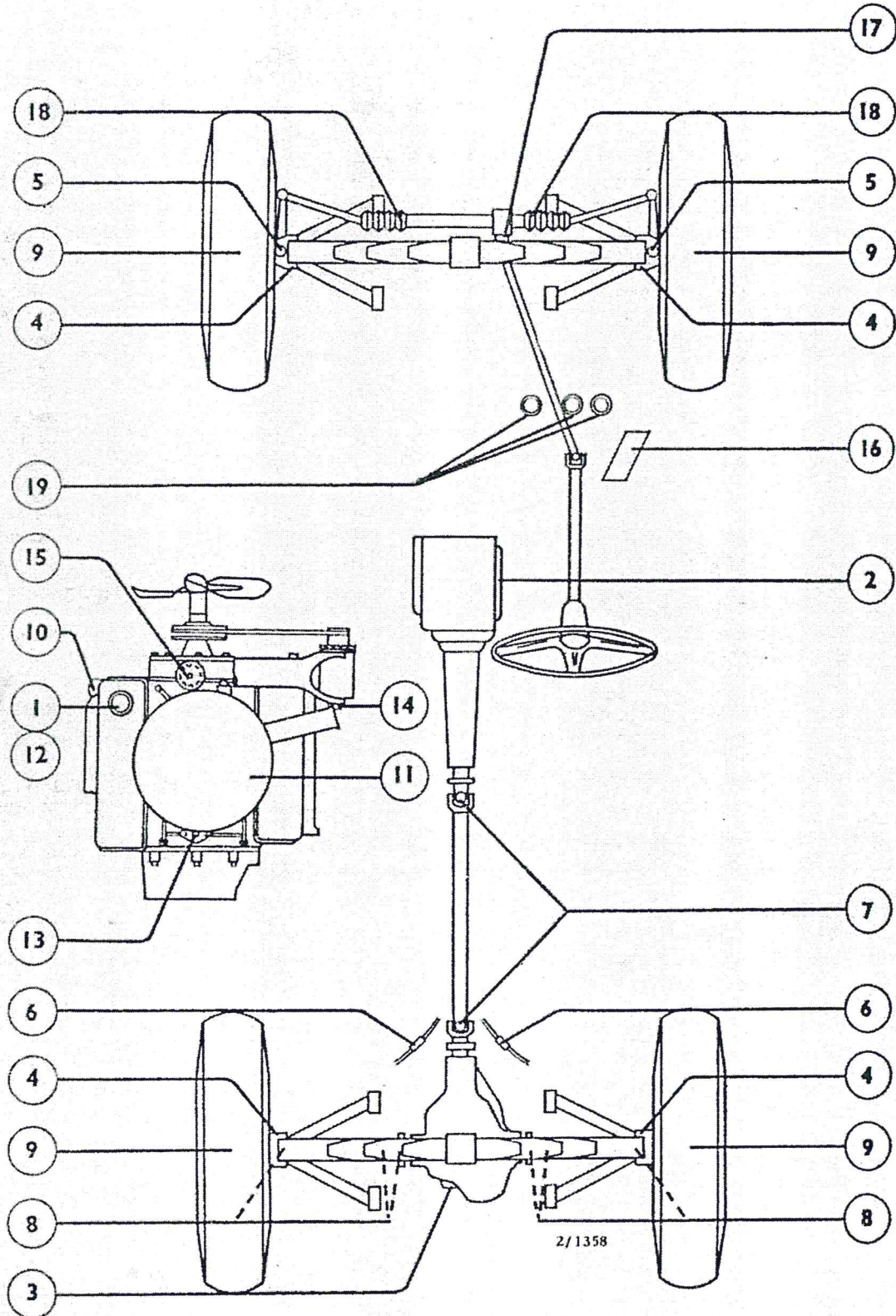

If you contemplating buying Jaguar parts for fixing your Cobra, let me recommend 'ROADBEND', below is a quote I got to recondition my Jag LSD rear end. The quote show parts and prices, I also found them very friendly and helpful.

Harry

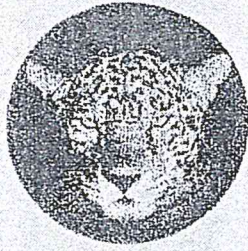

Roadbend

Independent Jaguar Specialists since 1965

Quotation

32 Welshpool Road, Welshpool Western Australia 6106

Phone (+618) 9362 1366 Fax (+618) 9470 3472 ABN 29 096 859 037

www.roadbend.com.au Email: parts@roadbend.com.au

Stock Code		Quantity	New		Second-Hand	
			Price	Total	Price	Total
JLM9732#	WHEEL BRG KIT RR XJ	2	\$55.00	\$110.00	\$0.00	\$0.00
JC16029#	FULCRUM BEARING	4	\$15.00	\$60.00	\$0.00	\$0.00
JC20178#	SEAL REAR HUB XJ6	4	\$3.00	\$12.00	\$0.00	\$0.00
JC16626	SHIM.004 PRELOAD E .XJ-3	6	\$3.56	\$21.36	\$0.00	\$0.00
JC16626/1	SHIM 003 CENTRALIZE E >X	6	\$3.25	\$19.50	\$0.00	\$0.00
CAC3818/10	SHIM HUB RR.1-10	2	\$19.50	\$39.00	\$0.00	\$0.00
GUJ111	KIT U/JOINT H/SHAFT XJ	4	\$26.95	\$107.80	\$0.00	\$0.00
JC17213	SEAL W/BONE RR.IN E >XJ	8	\$4.50	\$36.00	\$0.00	\$0.00
JC17168/1	TUBE-BEARING	4	\$14.50	\$58.00	\$0.00	\$0.00
JC17167	BEARING W/BONE RR. E >XJ	8	\$10.76	\$86.08	\$0.00	\$0.00
234532J	NIPPLE GREASE B/JOINT XJ	4	\$3.25	\$13.00	\$0.00	\$0.00
R/CALIPER	RECON & REPAIR REAR CALIPER	2	\$125.00	\$250.00	\$0.00	\$0.00
JLM1514#	KIT H/BRAKE PADS XJ1/2/3	1	\$35.00	\$35.00	\$0.00	\$0.00
JLM1513	BRAKE PADS REAR XJ	1	\$45.00	\$45.00	\$0.00	\$0.00
JLM1264#	SEAL OUTPUT SHAFT	2	\$14.95	\$29.90	\$0.00	\$0.00
JLM556	WASHER TAB DIFF O/PUT XJ	2	\$4.95	\$9.90	\$0.00	\$0.00
RTC1340	O RING DIFF O/PUT XJ-2&	2	\$3.00	\$6.00	\$0.00	\$0.00
CAC4999#	BEARING XJ40	4	\$16.95	\$67.80	\$0.00	\$0.00
RTC1348	SPACER H/SHAFT XJ-2&3	2	\$14.50	\$29.00	\$0.00	\$0.00
JJ3931#	DIFF HAT GASKET	1	\$7.00	\$7.00	\$0.00	\$0.00
CBC6923#	SEAL DIFF PIN. 1.875XJ-2>	1	\$14.00	\$14.00	\$0.00	\$0.00
JLM730#	KIT RR B/DISCS XJ/XJS	1	\$135.00	\$135.00	\$0.00	\$0.00
JJ9750	PLATE RETRACTION H/BRAKE	2	\$18.95	\$37.90	\$0.00	\$0.00
JJ9751	LOCKTAB H/BRAKE FORK XJ	2	\$3.55	\$7.10	\$0.00	\$0.00
PP412	ENAMEL ENG BLACK"300G"	1	\$12.50	\$12.50	\$0.00	\$0.00
PP426	ENAMEL ENG SILVER"300G"	1	\$12.50	\$12.50	\$0.00	\$0.00
LABOUR	LABOUR	10	\$85.00	\$850.00	\$0.00	\$0.00
			Total	\$2,111.34		\$0.00
			Total (Inc GST)	\$2,322.47		\$0.00

Couldn't you just cry

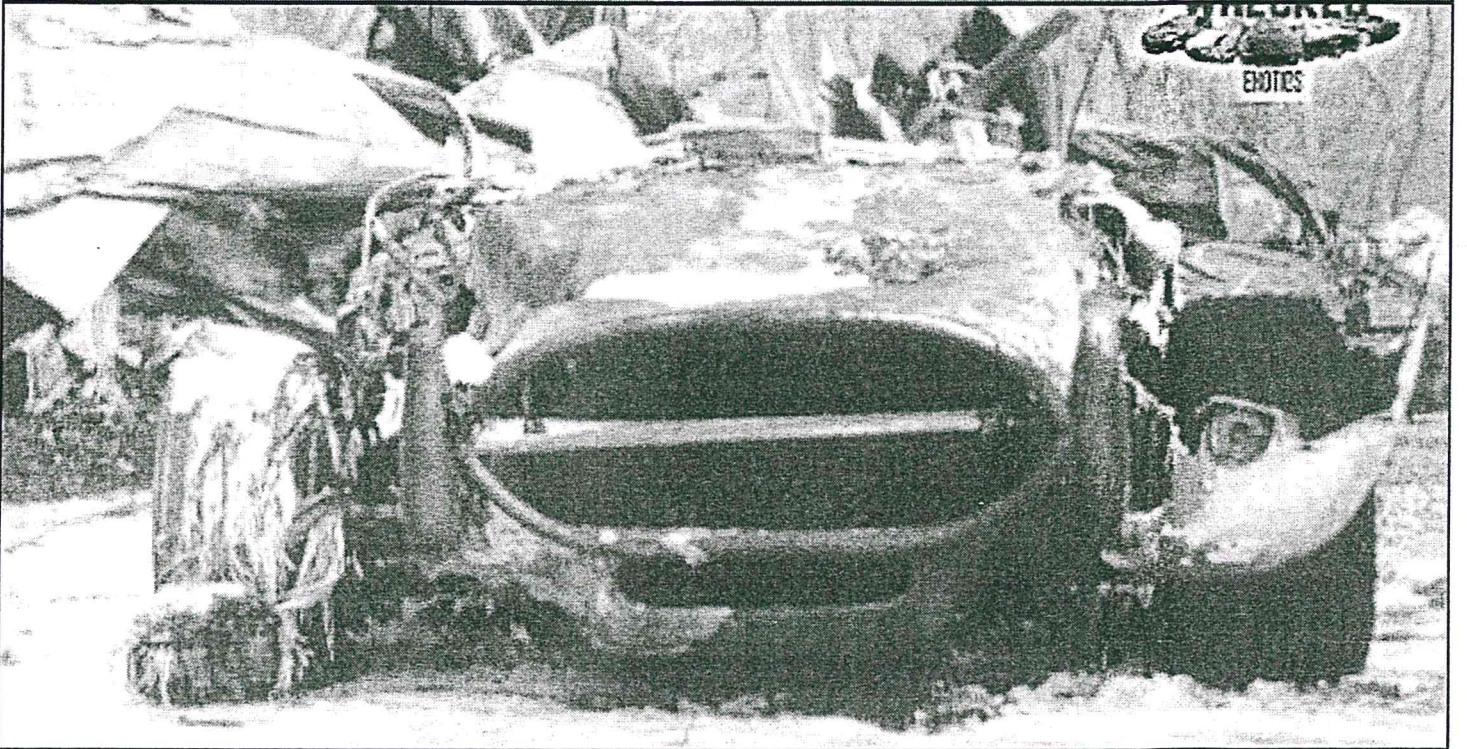
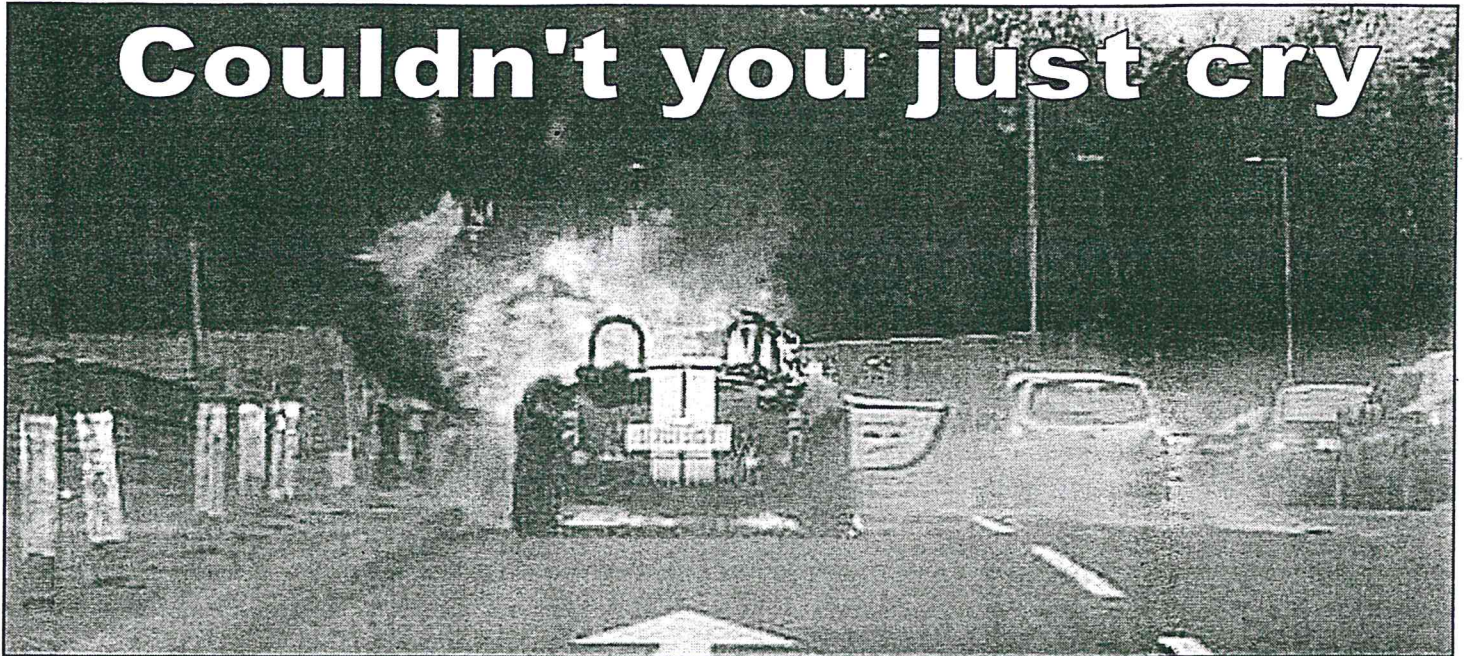

The Good Fairy

A married couple in their early 60s were out celebrating their 35th wedding anniversary in a quiet, romantic little restaurant. Suddenly, a tiny yet beautiful fairy appeared on their table and said, "For being such an exemplary married couple and for being faithful to each other for all this time, I will grant you each a wish."

"Oh, I want to travel around the world with my darling husband" said the wife.

The fairy waved her magic wand and - poof! - two tickets for the Queen

Mary II luxury liner appeared in her hands. Then it was the husband's turn.

He thought for a moment and said: "Well, this is all very

romantic, but an opportunity like this will never come again. I'm

sorry my love, but my wish is to have a wife 30 years younger than me."

The wife, and the fairy, were deeply disappointed, but a wish is a wish... So the fairy waved her magic wand and - poof! - the husband became 92 years old. The moral of the story:

Men are ungrateful idiots who should remember fairies are female.

CLUB CONTACTS

President:	Dave Kent	9497 9479
Vice President:	Terry Lovell	9454 3972
Secretary:	Rob Payne	9332 7278
Treasurer:	Dick Hogen-Esch	9581 2111
Club Captain:	Ron McNally	9582 1177
Committee:	Jessie Kent	9497 9479
	Colin Rainbird	9332 2677
	Rob Keene	9450 1531
	Brian Plank	9309 1314
	Jo Champion	9496 0387
Club Historians	Brian Plank	9309 1314
	Jessie Kent	94979479
Web Master:	Tony Forder	9332 1971
Snakeskin Editor:	Harry McClymans mclymans@opera.iinet.net	9307 4754